

DS Switch-Rated Plug and Receptacle



Main Advantages

- ▶ Switch & Hp rated (AC only)
- ▶ 65 kA to 100 kA short circuit rated*
- ▶ Up to 6 auxiliary contacts
- ▶ Amperage ratings up to 200 A
- ▶ Metal or Poly construction

* See note under General Ratings on the next page.



Highlighted Advantage



Simplify Compliance to NFPA 70E & CSA Z462 see pgs 19-20 for more information



▶ Features and Ratings	p. 40	▶ DS100	p. 49
▶ DS20	p. 41	▶ DS200	p. 51
▶ DS30	p. 43	▶ Spare Parts	p. 53
▶ DS60	p. 45	▶ Dimensions	p. 55
▶ DS100C	p. 47		

PRODUCT FEATURES

DECONTACTOR® Technology

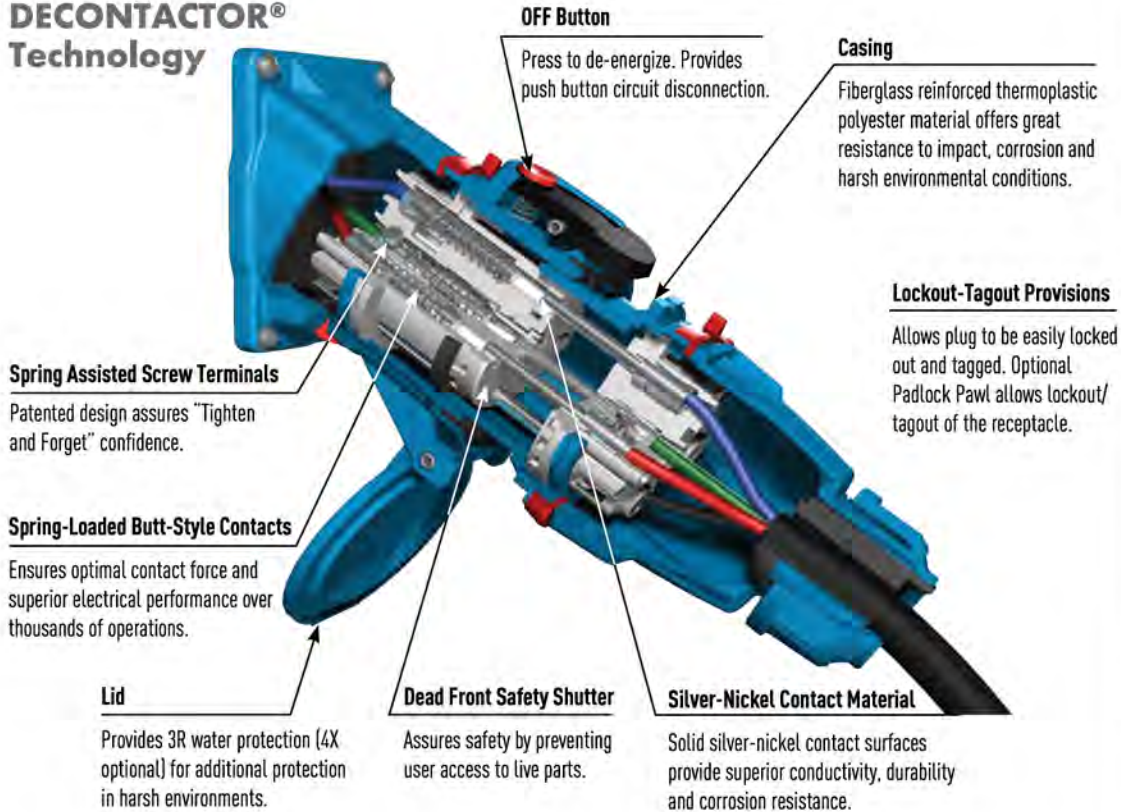

Operating Instructions



When the plug and receptacle are latched together, the circuit is connected.



Pressing the pawl breaks the connection and opens the circuit. The plug is ejected to its rest position; The contacts are now dead.



Rotating the 'dead' plug 30° counterclockwise closes the safety shutter and frees the plug to be withdrawn from the receptacle.



The plug and the receptacle are separated. The safety shutter prevents access to live parts.

5 To reconnect, insert plug into receptacle, rotate 30° clockwise, and apply insertion force.

General Ratings

Amperage	20 to 200 A
Voltage	600 VAC
Frequency	50-400 Hz
Horsepower	3/4 to 100 hp
Short-Circuit (Make & Withstand)	10kA to 100kA*
Environmental	Type 3R, Type 4X optional
Temperature	min -40°F/max 140°F

* DS20, 30, 60 & 100C are rated 100kA. Testing was performed with RK1 current limiting fuses sized at 400% of the highest full load motor ampacity associated with the devices hp rating.

* DS100 and DS200 are rated 65kA. Testing was performed with RK5 time delay fuses sized at 100% of the devices rated ampacity.

Highlighted Feature

Typical Device Labels



MELTRIC DS Series Switch-Rated devices are UL & CSA rated for "motor circuit" and "branch circuit" disconnect switching – up to 100 hp and up to 200 A.

Listings

Category	UL	CSA	IEC
Plugs and Receptacles	UL 1682	C22.2 No. 182.1	60309-1
Branch Circuit Disconnect Switching (AC only)	UL Subject 2682 (Performance tests from UL 98)	UL Subject 2682	60947-3, AC22, AC23
Motor Circuit Disconnect Switching (AC only)	UL Subject 2682 (Performance tests from UL 98)	UL Subject 2682	60947-3, AC22, AC23

CE ratings available upon request.

DS20 Switch-Rated Plugs & Receptacles – 20 A

UL/CSA Ratings

- **Max Amperage & Voltage**
20 A, 600 VAC
- **Switch-Rating (AC Only)**
Branch Circuit & Motor Circuit
Disconnect Switching
- **Horsepower Ratings**

120V	1Ø	.75 hp
208V	3Ø	3 hp
240V	3Ø	5 hp
480V	3Ø	7.5 hp
600V	3Ø	10 hp
- **Short Circuit Rating**
100kA Close & Withstand
Tested with RK1 current limiting
fuses sized at 400% of the highest
full load motor ampacity.
- **Environmental Ratings**
Type 3R (Standard)
Type 4X (Optional)
- **Temperature Range**
Min -40°F/Max 140°F
See pg 258 for temps below -15°F.
- **Wiring Capacity**
Min 14 AWG Max 8 AWG Aux
Contact - Max 14 AWG
Based on THHN wire sizes
- **Certifications**
UL 2682, UL 1682, CSA 182.1

Receptacle (female)



Inlet (male)



! Don't forget to add installation accessories to your order

North American UL/CSA Configuration

Voltage	Polarity	Part # Poly	Part # Poly
120V	1P+N+G	33-14165	33-18165
120 208V	3P+N+G	33-14167	33-18167
125V	1P+N+G	33-14075	33-18075
125 250V	2P+N+G	33-14076	33-18076
208V	2P+G	33-14162	33-18162
208V	3P+G	33-14163	33-18163
250V	2P+G	33-14072	33-18072
250V	3P+G	33-14073	33-18073
277V	1P+N+G	33-14045	33-18045
277 480V	3P+N+G	33-14047	33-18047
347 600V	3P+N+G	33-14167	33-18167
480V	2P+G	33-14042	33-18042
480V	3P+G	33-14043	33-18043
600V	2P+G	33-14142	33-18142
600V	3P+G	33-14143	33-18143

For international configurations and ratings (IEC/CE) visit meltric.com/international-catalog or contact customer service at 800-433-7642.

Main Options



**Auxiliary/Pilot
Contacts**



**Mushroom
Pawl**



Padlock Pawl



**Closed Lid
Configuration**
Recommended for card
applicators to keep lid
locked in to avoid damage.

Receptacle Options

Suffix

Inlet Options

Suffix

- With 2 Auxiliary/Pilot Contacts
- Type 4X & Closed Lid Configuration
- Straight Insertion
- Self-Ejecting Connector Release
- Mushroom Pawl
- Padlock Pawl
- Padlockable Mushroom Pawl
- Screw-Type Locking Pawl
- Metal Pawl (on Poly Receptacle)
- Closed Lid Configuration
- With Auxiliary Switch

- Recept # - 972**
- Recept # - 4X**
- Recept # - 352**
- Recept # - 354**
- Recept # - 375**
- Recept # - 843**
- Recept # - 375-843**
- Recept # - 845**
- Recept # - 824**
- Recept # - NC**
- Recept # - 270+**

- With 2 Auxiliary/Pilot Contacts
- Type 4X Watertightness
- Self-Ejecting Plug Release
- With No Lockout Hole
- For Auxiliary Switch

Notes: * Order inlet with P+N+G configuration and receptacle with P+G configuration.

Notes: + Not UL/CSA listed.

! See pages 235-244 for detailed information on these options

Order Example: 208V DS20 + 2 auxiliary contacts
DS20 Poly inlet 2P+G = 33-18162-972

INSTALLATION ACCESSORIES – SIZE 2

Unless indicated otherwise, accessories can be used with either poly or metal plugs and receptacles.

HANDLES

HANDLE w/NPT	Part # Poly	Part # Metal
 Poly 1/2"	512P0N05	592P0N05
3/4"	512P0N07	592P0N07
1"	512P0N10	592P0N10
1 1/4"	512P0N12	-

For available cord grips, see page 167.

POLY HANDLE w/CORD GRIP	Cable Range	Part #
	.350 - .520"	712P0BP6
	.520 - .680"	712P0CP5
	.680 - .980"	712P0DP4
	.980 - 1.260"	712P0EP4

METAL HANDLE w/CORD GRIP	Cable Range	Part #
	.438 - .500"	792P0BS3
	.500 - .562"	792P0BS4
	.562 - .625"	792P0CS2
	.625 - .750"	792P0CS4
	.750 - .875"	792P0DS1
	.875 - 1.000"	792P0DS3

POLY HANDLE	Cable Range	Part #
	.20 - .83"	512P0D21

POLY HANDLE w/CLAMP & BUSHING	Cable Range	Part #
	.750 - .875"	712P0S14
	.875 - 1.000"	712P0S16
	1.000 - 1.125"	712P0S18
	1.125 - 1.250"	712P0S20
	1.250 - 1.375"	712P0S22

ANGLES

POLY ANGLE	Angle	Part #
	30°	512M3

POLY ANGLE	Angle	Part #	Notes
	70°	512M7	Panel mounting only.

METAL ANGLE	Angle	Part #
	0°	592M0

METAL ANGLE	Angle	Part #
	30°	592M3

METAL ANGLE	Angle	Part #	Notes
	FS/FD Box 30°	792M3FS	* Base measures approximately 4.2" x 2.7". Due to the variation in sizes of FS boxes, please verify that your FS box matches our dimensions, if not call Customer Service for other solutions.

BOXES

POLY CONDUIT ENTRY w/NPT	Angle	Part #	Notes
	30° 1/2"	512B3N05	For poly devices only
	30° 3/4"	512B3N07	* Interior volume with receptacle installed.

POLY WALL BOX w/ANGLE	Angle	Part #	Notes
	70°	512C7000	70° poly boxes are not drilled. Contact Customer Service if factory drilling is required.

GROUND BAR	Part #	Notes
	51AA089	* Interior volume with receptacle installed.

POLY ANGLE WITH METAL BOX w/NPT	Angle	Part #	Notes
	70° 1/2"	712C7N05	
	70° 3/4"	712C7N07	
	70° 1"	712C7N10	* Interior volume with receptacle installed.
	70° 1 1/4"	712C7N12	
	70° 1 1/2"	712C7N15	

METAL BOX w/NPT	Angle	Part #
	0° 1/2"	7T1F0N05
	0° 3/4"	7T1F0N07
	0° 1"	7T1F0N10
	0° 1 1/4"	7T1F0N12

POLY ANGLE WITH METAL BOX w/NPT	Angle	Part #	Notes
	30° 1/2"	712C3N05	
	30° 3/4"	712C3N07	* Interior volume with receptacle installed.
	30° 1"	712C3N10	
	30° 1 1/4"	712C3N12	

NPT on top or bottom (if rotated). For other NPT configurations, contact Customer Service.

MISCELLANEOUS ACCESSORIES

FINGER DRAWPLATES	Part #	Notes
	61-3A346	Set of Two (2) Recommended for cord to cord assembly applications, for easier connector closure.

PROTECTIVE INLET/PLUG CAP	Part #	Notes
	31-1A426	For Inlets/Plugs Only.

PADLOCKABLE INLET/PLUG CAP	Part #	Notes
	DS1PC	For Inlets/Plugs Only.

SPRING-LOADED PADLOCKABLE INLET/PLUG CAP	Part #	Notes
	31-1A226	For Inlets/Plugs Only. -A155 suffix required to maintain water ingress protection.

EASY RETROFIT ADAPTER PLATES	Part #	Notes
	see pg 164	Mount to existing boxes.

RECEPTACLE LOCKING PIN	Part #	Notes
	LP-843	Requires Padlockable Pawl option (-843) on receptacle.

DS30 Switch-Rated Plugs & Receptacles – 30 A

UL/CSA Ratings

- **Max Amperage & Voltage**
30 A, 600 VAC
- **Switch-Rating (AC Only)**
Branch Circuit & Motor Circuit Disconnect Switching
- **Horsepower Ratings**

120V	1Ø	1 1/2 hp
240V	1Ø	3 hp
208V	3Ø	5 hp
240V	3Ø	5 hp
480V	3Ø	15 hp
600V	3Ø	15 hp
- **Short Circuit Rating**
100kA Close & Withstand
Tested with RK1 current limiting fuses sized at 400% of the highest full load motor ampacity.
- **Environmental Ratings**
Type 3R (Standard)
Type 4X (Optional)
- **Temperature Range**
Min -40°F/Max 140°F
See pg 258 for temps below -15°F.
- **Wiring Capacity**
Min 12 AWG Max 4 AWG
Aux Contacts - Max 14 AWG
Based on THHN wire sizes
- **Certifications**
UL 2682, UL 1682, CSA 182.1

Receptacle (female)



Inlet (male)



! Don't forget to add installation accessories to your order

North American UL/CSA Configurations

Voltage	Polarity	Part # Poly	Part # Poly
120V	1P+N+G	33-34165	33-38165
120 208V	3P+N+G	33-34167	33-38167
125V	1P+N+G	33-34075	33-38075
125 250V	2P+N+G	33-34076	33-38076
208V	2P+G	33-34162	33-38162
208V	3P+G	33-34163	33-38163
250V	2P+G	33-34072	33-38072
250V	3P+G	33-34073	33-38073
277V	1P+N+G	33-34045	33-38045
277 480V	3P+N+G	33-34047	33-38047
347 600V	3P+N+G	33-34167	33-38167
480V	2P+G	33-34042	33-38042
480V	3P+G	33-34043	33-38043
600V	2P+G	33-34142	33-38142
600V	3P+G	33-34143	33-38143

For international configurations and ratings (IEC, CE) visit meltric.com/international-catalog or contact Customer Service at 800-433-7642.

Main Options

-  **Auxiliary/Pilot Contacts**
-  **Mushroom Pawl**
-  **Padlock Pawl**
-  **Closed Lid Configuration**
Recommended for cord applications to keep lid locked in to avoid damage.

Receptacle Options

Suffix

Inlet Options

Suffix

With 2 Auxiliary/Pilot Contacts	Recept # -972	With 2 Auxiliary/Pilot Contacts	Inlet # -972
With 3 Auxiliary/Pilot Contacts	Recept # -973	With 3 Auxiliary/Pilot Contacts	Inlet # -973
With 4 Auxiliary/Pilot Contacts	Recept # -974	With 4 Auxiliary/Pilot Contacts	Inlet # -974
Type 4X & Closed Lid Configuration	Recept # -4X	Type 4X Watertightness	Inlet # -4X
Straight Insertion	Recept # -352	Self-Ejecting Plug Release	Inlet # -338
Self-Ejecting Connector Release	Recept # -354	With No Lockout Hole	Inlet # -A155
Mushroom Pawl	Recept # -375	For Auxiliary Switch	Inlet # -NNF*
Padlock Pawl	Recept # -843		
Padlockable Mushroom Pawl	Recept # -375-843		
Screw-Type Locking Pawl	Recept # -845		
Metal Pawl (on Poly Receptacle)	Recept # -824		
Closed Lid Configuration	Recept # -NC		
With Auxiliary Switch	Recept # -270+		

Notes: * Order inlet with P+N+G configuration and receptacle with P+G configuration.

Notes: + Not UL/CSA listed.

Order Example: 480V DS30 + 2 auxiliary contacts

DS30 Poly inlet 3P+G = 33-38043-972

! See pages 235-244 for detailed information on these options

INSTALLATION ACCESSORIES – SIZE 3

Unless indicated otherwise, accessories can be used with either poly or metal plugs and receptacles.

HANDLES

HANDLE w/NPT		Part # Poly	Part # Metal
	Poly 1/2"	513P0N05	593P0N05
	3/4"	513P0N07	593P0N07
	Metal 1"	513P0N10	593P0N10
	1 1/4"	513P0N12	593P0N12

For available cord grips, see page 167.

POLY HANDLE w/CORD GRIP	Cable Range	Part #
	.520 - .680"	713P0CP5
	.680 - .980"	713P0DP4
	.980 - 1.260"	713P0EP4

METAL HANDLE w/CORD GRIP	Cable Range	Part #
	.625 - .750"	793P0CS4
	.750 - .875"	793P0DS1
	.875 - 1.000"	793P0DS3
	1.000 - 1.125"	793P0ES2

POLY HANDLE	Cable Range	Part #
	.39 - 1.18"	513P0D30

POLY HANDLE w/BUILT IN DRAW GRIPS	Cable Range	Part #
	.39 - 1.18"	513P0D30473

Makes connector closures easier.

POLY HANDLE w/CLAMP & BUSHING	Cable Range	Part #
	.750 - .875"	713P0S14
	.875 - 1.000"	713P0S16
	1.000 - 1.125"	713P0S18
	1.125 - 1.250"	713P0S20
	1.250 - 1.375"	713P0S22

ANGLES

POLY ANGLE		Part #
	30°	513M3

POLY ANGLE		Part #	Notes
	70°	513M7	Panel mounting only.

METAL ANGLE		Part #
	0°	593M0

METAL ANGLE		Part #
	30°	593M3

METAL ANGLE		Part #	Notes
	FS/FD Box 30°	793M3FS	* Base measures approximately 4.2" x 2.7". Due to the variation in sizes of FS boxes, please verify that your FS box matches our dimensions, if not call Customer Service for other solutions.

METAL ANGLE		Part #
	70°	593M7

BOXES

POLY CONDUIT ENTRY w/NPT			Part #	Notes
	30°	1/2"	513B3N05	For poly devices only.
	30°	3/4"	513B3N07	* Interior volume with receptacle installed.
	30°	1"	513B3N10	

POLY WALL BOX w/ANGLE			Part #	Notes
	70°		513C7000	70° poly boxes are not drilled. Contact Customer Service if factory drilling is required.

GROUND BAR			Part #	Notes
			51AA089	* Interior volume with receptacle installed.

POLY ANGLE WITH METAL BOX w/NPT			Part #	Notes
	70°	1/2"	713C7N05	* Interior volume with receptacle installed.
	70°	3/4"	713C7N07	
	70°	1"	713C7N10	
	70°	1 1/4"	713C7N12	
	70°	1 1/2"	713C7N15	

METAL BOX w/NPT			Part #
	0°	1/2"	7T1F0N05
	0°	3/4"	7T1F0N07
	0°	1"	7T1F0N10
	0°	1 1/4"	7T1F0N12

POLY ANGLE WITH METAL BOX w/NPT			Part #	Notes
	30°	1/2"	713C3N05	* Interior volume with receptacle installed.
	30°	3/4"	713C3N07	
	30°	1"	713C3N10	
	30°	1 1/4"	713C3N12	

NPT on top or bottom (if rotated). For other NPT configurations, contact Customer Service.

MISCELLANEOUS ACCESSORIES

FINGER DRAWPLATES		Part #	Notes
		61-6A346	Set of Two (2) Recommended for cord to cord assembly applications, for easier connector closure.

PROTECTIVE INLET/PLUG CAP		Part #	Notes
		31-3A426	For Inlets/Plugs Only.

PADLOCKABLE INLET/PLUG CAP		Part #	Notes
		DS3PC	For Inlets/Plugs Only.

SPRING-LOADED PADLOCKABLE INLET/PLUG CAP		Part #	Notes
		31-3A226	For Inlets/Plugs Only. -A155 suffix required to maintain water ingress protection.

EASY RETROFIT ADAPTER PLATES		Part #	Notes
		see pg 164	Mount to existing boxes.

RECEPTACLE LOCKING PIN		Part #	Notes
		LP-843	Requires Padlockable Pawl option (-843) on receptacle.

DS60 Switch-Rated Plugs & Receptacles – 60 A

UL/CSA Ratings

- Max Amperage & Voltage**
60 A, 600 VAC
- Switch-Rating (AC Only)**
Branch Circuit & Motor Circuit Disconnect Switching
- Horsepower Ratings**

120V	1Ø	3 hp
240V	1Ø	5 hp
208V	3Ø	10 hp
240V	3Ø	10 hp
480V	3Ø	25 hp
600V	3Ø	25 hp
- Short Circuit Rating**
100kA Close & Withstand
Tested with RK1 current limiting fuses sized at 400% of the highest full load motor ampacity.
- Environmental Ratings**
Type 3R (Standard)
Type 4X (Optional)
- Temperature Range**
Min -40°F/Max 140°F
See pg 258 for temps below -15°F.
- Wiring Capacity**
Min 10 AWG Max 2 AWG Aux Contacts - Max 14 AWG
Based on THHN wire sizes
- Certifications**
UL 2682, UL 1682, CSA 182.1

Receptacle (female)



Inlet (male)



! Don't forget to add installation accessories to your order

North American UL/CSA Configuration

Voltage	Polarity	Part #		Part #	
		Poly	Metal	Poly	Metal
120V	1P+N+G	33-64165	37-64165	33-68165	37-68165
120 208V	3P+N+G	33-64167	37-64167	33-68167	37-68167
125V	1P+N+G	33-64075	37-64075	33-68075	37-68075
125 250V	2P+N+G	33-64076	37-64076	33-68076	37-68076
208V	2P+G	33-64162	37-64162	33-68162	37-68162
208V	3P+G	33-64163	37-64163	33-68163	37-68163
250V	2P+G	33-64072	37-64072	33-68072	37-68072
250V	3P+G	33-64073	37-64073	33-68073	37-68073
277V	1P+N+G	33-64045	37-64045	33-68045	37-68045
277 480V	3P+N+G	33-64047	37-64047	33-68047	37-68047
347 600V	3P+N+G	33-64147	37-64147	33-68147	37-68147
480V	2P+G	33-64042	37-64042	33-68042	37-68042
480V	3P+G	33-64043	37-64043	33-68043	37-68043
600V	2P+G	33-64142	37-64142	33-68142	37-68142
600V	3P+G	33-64143	37-64143	33-68143	37-68143

For international configurations and ratings (IEC/CE) visit meltric.com/international-catalog or contact customer service at 800-433-7642.

Main Options

-  **Auxiliary/Pilot Contacts**
-  **Mushroom Pawl**
-  **Padlock Pawl**
-  **Closed Lid Configuration**
Recommended for cord applications to keep lid tucked in to avoid damage

Receptacle Options

- With 2 Auxiliary/Pilot Contacts **Recept # - 972**
- With 3 Auxiliary/Pilot Contacts **Recept # - 263**
- With 4 Auxiliary/Pilot Contacts **Recept # - 264**
- Type 4X & Closed Lid Configuration **Recept # - 4X**
- Straight Insertion **Recept # - 352**
- Self-Ejecting Connector Release **Recept # - 354**
- Mushroom Pawl **Recept # - 375**
- Padlock Pawl **Recept # - 843**
- Padlockable Mushroom Pawl **Recept # - 375-843**
- Screw-Type Locking Pawl **Recept # - 845**
- Metal Pawl (on Poly Receptacle) **Recept # - 824**
- Closed Lid Configuration **Recept # - NC**
- With Auxiliary Switch **Recept # - 270+**
- 180° Opening Lid (metal only) **Recept # - 180++**

Inlet Options

- With 2 Auxiliary/Pilot Contacts **Inlet # - 972**
- With 3 Auxiliary/Pilot Contacts **Inlet # - 263**
- With 4 Auxiliary/Pilot Contacts **Inlet # - 264**
- Type 4X Watertightness **Inlet # - 4X**
- Self-Ejecting Plug Release **Inlet # - 338**
- With No Lockout Hole **Inlet # - A155**
- For Auxiliary Switch **Inlet # - NNF***

Notes: * Order inlet with P+N+G configuration and receptacle with P+G configuration.





Notes: + Not UL/CSA listed.
++ Required when mating to rigid mounted male inlet.

Order Example: 480V DS60 + 2 auxiliary contacts
DS60 Poly inlet 3P+G = 33-68043-972

INSTALLATION ACCESSORIES – SIZE 4

Unless indicated otherwise, accessories can be used with either poly or metal plugs and receptacles.

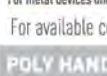
HANDLES

HANDLE w/NPT	Part # Poly	Part # Metal
 1/2"	514P0N05	594P0N05
 3/4"	514P0N07	594P0N07
 1"	514P0N10	594P0N10
 1 1/4"	514P0N12	594P0N12
 1 1/2"	514P0N15	594P0N15

For metal devices only

For available cord grips, see page 167.

POLY HANDLE w/CORD GRIP	Cable Range	Part #
	.680 - .980"	714P0DP4
	.980 - 1.260"	714P0EP4
	1.260 - 1.560"	714P0FP1

METAL HANDLE w/CORD GRIP	Cable Range	Part #
	.750 - .875"	794P0DS1
	.875 - 1.000"	794P0DS3
	1.000 - 1.125"	794P0ES2
	1.250 - 1.375"	794P0FS1
	1.438 - 1.562"	794P0FS2*
	1.562 - 1.688"	794P0FS3*

For metal devices only

*May require stripping of cable jacket.

POLY HANDLE	Cable Range	Part #
	.51 - 1.38"	514P0D35

POLY HANDLE w/BUILT IN DRAW GRIPS	Cable Range	Part #
	.51 - 1.38"	514P0D35473

Makes connector closures easier.

POLY HANDLE w/CLAMP & BUSHING	Cable Range	Part #
	1.250 - 1.375"	714P0S22
	1.438 - 1.562"	714P0S25
	1.562 - 1.688"	714P0S27
	1.688 - 1.812"	714P0S29

ANGLES

POLY ANGLE	Angle	Part # Poly	Part # Metal
	30°	514M3	514M7
	70°		Panel mounting only.

METAL ANGLE	Angle	Part #	Notes
	0°	594M0	
	30°	594M3	
	30°	794M3L	
	Oversized 30°	794M3	Mounts on oversize box only. Order with 715F0Nxx. See pg 50.
	70°	594M7	

BOXES

POLY CONDUIT ENTRY w/NPT	Angle	Size	Part #	Notes
	30°	1/2"	514B3N05	For poly devices only * Interior volume with receptacle installed.
	30°	3/4"	514B3N07	
	30°	1"	514B3N10	
	30°	1 1/4"	514B3N12	

POLY WALL BOX w/ANGLE	Angle	Part #	Notes
	70°	514C7000	70° poly boxes are not drilled. Contact Customer Service if factory drilling is required. * Interior volume with receptacle installed.
	Ground Bar	51AA089	

POLY ANGLE WITH METAL BOX w/NPT	Angle	Size	Part #	Notes
	70°	1/2"	714C7N05	* Interior volume with receptacle installed.
	70°	3/4"	714C7N07	
	70°	1"	714C7N10	
	70°	1 1/4"	714C7N12	
	70°	1 1/2"	714C7N15	

METAL BOX w/NPT	Angle	Size	Part #
	0°	1"	7T4F0N10
	0°	1 1/4"	7T4F0N12
	0°	1 1/2"	7T4F0N15
	0°	2"	7T4F0N20



POLY ANGLE WITH METAL BOX w/NPT	Angle	Size	Part #	Notes
	30°	1"	714C3N10	For metal angle, replace "71" prefix with "79". * Interior volume with receptacle installed.
	30°	1 1/4"	714C3N12	
	30°	1 1/2"	714C3N15	
	30°	2"	714C3N20	

* 61.0 in³ Poly Angle
* 59.4 in³ Metal Angle

MISCELLANEOUS ACCESSORIES

FINGER DRAWPLATES	Part #	Notes
	31-6A346	Set of Two (2) Recommended for cord to cord assembly applications, for easier connector closure.

PROTECTIVE INLET/PLUG CAP	Part #	Notes
	31-6A426	For Inlets/Plugs Only.

PADLOCKABLE INLET/PLUG CAP	Part #	Notes
	DS6PC	Poly – For Inlets/Plugs Only.
	DS6MC	Aluminum – For Inlets/Plugs Only. -A155 suffix required to maintain water ingress protection.

SPRING-LOADED PADLOCKABLE INLET/PLUG CAP	Part #	Notes
	31-6A226	For Poly Inlets/Plugs Only. -A155 suffix required to maintain water ingress protection.
	39-6A226	For Metal Inlets/Plugs Only.

RECEPTACLE LOCKING PIN	Part #	Notes
	LP-843	Requires Padlockable Pawl option (-843) on receptacle.

DS100C Switch-Rated Plugs & Receptacles – 100 A

UL/CSA Ratings

- **Max Amperage & Voltage**
100 A, 600 VAC
- **Switch-Ratings (AC Only)**
Branch Circuit & Motor Circuit Disconnect Switching
- **Horsepower Ratings**

120V	1Ø	5 hp
240V	1Ø	10 hp
208V	3Ø	20 hp
240V	3Ø	20 hp
480V	3Ø	50 hp
600V	3Ø	50 hp
- **Short Circuit Rating**
100kA Close & Withstand
Tested with RK1 current limiting fuses sized at 400% of the highest full load motor ampacity.
- **Environmental Ratings**
Type 3R (Standard)
Type 4X (Optional)
- **Temperature Range**
Min -40°F/Max 140°F
See pg 258 for temps below -15°F.
- **Wiring Capacity**
Min 10 AWG Max 2 AWG
Aux Contacts - Max 14 AWG
Based on THHN wire sizes
- **Certifications**
UL 2682, UL 1682, CSA 182.1

Receptacle (female)



Inlet (male)



! Don't forget to add installation accessories to your order

North American UL/CSA Configurations

Voltage	Polarity	Part #		Part #	
		Poly	Metal	Poly	Metal
120V	1P+N+G	33-64235-C-K16	37-64235-C-K16	33-68235-C-K16	37-68235-C-K16
120 208V	3P+N+G	33-64237-C-K16	37-64237-C-K16	33-68237-C-K16	37-68237-C-K16
125V	1P+N+G	33-64175-C-K07	37-64175-C-K07	33-68175-C-K07	37-68175-C-K07
125 250V	2P+N+G	33-64176-C-K07	37-64176-C-K07	33-68176-C-K07	37-68176-C-K07
208V	2P+G	33-64232-C-K16	37-64232-C-K16	33-68232-C-K16	37-68232-C-K16
208V	3P+G	33-64233-C-K16	37-64233-C-K16	33-68233-C-K16	37-68233-C-K16
250V	2P+G	33-64172-C-K07	37-64172-C-K07	33-68172-C-K07	37-68172-C-K07
250V	3P+G	33-64173-C-K07	37-64173-C-K07	33-68173-C-K07	37-68173-C-K07
277V	1P+N+G	33-64245-C-K04	37-64245-C-K04	33-68245-C-K04	37-68245-C-K04
277 480V	3P+N+G	33-64247-C-K04	37-64247-C-K04	33-68247-C-K04	37-68247-C-K04
347 600V	3P+N+G	33-64187-C-K14	37-64187-C-K14	33-68187-C-K14	37-68187-C-K14
480V	2P+G	33-64242-C-K04	37-64242-C-K04	33-68242-C-K04	37-68242-C-K04
480V	3P+G	33-64243-C-K04	37-64243-C-K04	33-68243-C-K04	37-68243-C-K04
600V	2P+G	33-64182-C-K14	37-64182-C-K14	33-68182-C-K14	37-68182-C-K14
600V	3P+G	33-64183-C-K14	37-64183-C-K14	33-68183-C-K14	37-68183-C-K14

For international configurations and ratings (IEC, CE) visit meltric.com/international-catalog or contact Customer Service at 800-433-7642.

Main Options

-  **Auxiliary/Pilot Contacts**
-  **Mushroom Pawl**
-  **Padlock Pawl**
-  **Closed Lid Configuration**
Recommended for cord applications to keep lid locked in to avoid damage.

Receptacle Options

- With 2 Auxiliary/Pilot Contacts **Recept # - 972**
- With 3 Auxiliary/Pilot Contacts **Recept # - 263**
- With 4 Auxiliary/Pilot Contacts **Recept # - 264**
- Type 4X & Closed Lid Configuration **Recept # - 4X**
- Straight Insertion **Recept # - 352**
- Self-Ejecting Connector Release **Recept # - 354**
- Mushroom Pawl **Recept # - 375**
- Padlock Pawl **Recept # - 843**
- Padlockable Mushroom Pawl **Recept # - 375-843**
- Screw-Type Locking Pawl **Recept # - 845**
- Metal Pawl (on Poly Receptacle) **Recept # - 824**
- Closed Lid Configuration **Recept # - NC**
- With Auxiliary Switch **Recept # - 270+**
- 180° Opening Lid (metal only) **Recept # - 180++**

Inlet Options

- With 2 Auxiliary/Pilot Contacts **Inlet # - 972**
- With 3 Auxiliary/Pilot Contacts **Inlet # - 263**
- With 4 Auxiliary/Pilot Contacts **Inlet # - 264**
- Type 4X Watertightness **Inlet # - 4X**
- Self-Ejecting Plug Release **Inlet # - 338**
- With No Lockout Hole **Inlet # - A155**
- For Auxiliary Switch **Inlet # - NNF***

Notes: * Order inlet with P+N+G configuration and receptacle with P+G configuration.

Notes: + Not UL/CSA listed.
++ Required when mating to rigid mounted male inlet.

Order Example: 480V DS100C + 2 auxiliary contacts
DS100C Poly inlet 3P+G = 33-68243-C-K04-972

INSTALLATION ACCESSORIES – SIZE 4

Unless indicated otherwise, accessories can be used with either poly or metal plugs and receptacles.

HANDLES

HANDLE w/NPT		Part # Poly	Part # Metal
	1/2"	514P0N05	594P0N05
	3/4"	514P0N07	594P0N07
	1"	514P0N10	594P0N10
	1 1/4"	514P0N12	594P0N12
	1 1/2"	514P0N15	594P0N15

For metal devices only
For available cord grips, see page 167.

POLY HANDLE w/CORD GRIP	Cable Range	Part #
	.680 - .980"	714P0DP4
	.980 - 1.260"	714P0EP4
	1.260 - 1.560"	714P0FP1

METAL HANDLE w/CORD GRIP	Cable Range	Part #
	.750 - .875"	794P0DS1
	.875 - 1.000"	794P0DS3
	1.000 - 1.125"	794P0ES2
	1.250 - 1.375"	794P0FS1
	1.438 - 1.562"	794P0FS2*
	1.562 - 1.688"	794P0FS3*

*May require stripping of cable jacket.

POLY HANDLE	Cable Range	Part #
	.51 - 1.38"	514P0D35

POLY HANDLE w/BUILT IN DRAW GRIPS	Cable Range	Part #
	.51 - 1.38"	514P0D35473

Makes connector closures easier.

POLY HANDLE w/CLAMP & BUSHING	Cable Range	Part #
	1.250 - 1.375"	714P0S22
	1.438 - 1.562"	714P0S25
	1.562 - 1.688"	714P0S27
	1.688 - 1.812"	714P0S29

ANGLES

POLY ANGLE		Part #	Angle	Part #	Angle
	30°	514M3		70°	514M7
					Panel mounting only.

METAL ANGLE		Part #
	0°	594M0
	30°	594M3
	30°	794M3L
	Oversized 30°	794M3
	70°	594M7

Mounts on oversize box only. Order with 715F0Nxx. See pg 50.

BOXES

POLY CONDUIT ENTRY w/NPT		Part #
	30° 1/2"	514B3N05
	30° 3/4"	514B3N07
	30° 1"	514B3N10
	30° 1 1/4"	514B3N12

* 27.7 in³

For poly devices only
* Interior volume with receptacle installed.

POLY WALL BOX w/ANGLE		Part #
	70°	514C7000

* 181.24 in³

70° poly boxes are not drilled. Contact Customer Service if factory drilling is required.
* Interior volume with receptacle installed.

POLY ANGLE WITH METAL BOX w/NPT		Part #
	70° 1/2"	714C7N05
	70° 3/4"	714C7N07
	70° 1"	714C7N10
	70° 1 1/4"	714C7N12
	70° 1 1/2"	714C7N15

* 177.7 in³

* Interior volume with receptacle installed.

METAL BOX w/NPT		Part #
	0° 1"	7T4F0N10
	0° 1 1/4"	7T4F0N12
	0° 1 1/2"	7T4F0N15
	0° 2"	7T4F0N20

POLY ANGLE WITH METAL BOX w/NPT		Part #
	30° 1"	714C3N10
	30° 1 1/4"	714C3N12
	30° 1 1/2"	714C3N15
	30° 2"	714C3N20



* 61.0 in³ Poly Angle
* 59.4 in³ Metal Angle

For metal angle, replace "71" prefix with "79".
* Interior volume with receptacle installed.

MISCELLANEOUS ACCESSORIES

FINGER DRAWPLATES	
	31-6A346 Set of Two (2) Recommended for cord to cord assembly applications, for easier connector closure.

PROTECTIVE INLET/PLUG CAP	
	31-6A426 For Inlets/Plugs Only.

PADLOCKABLE INLET/PLUG CAP	
	DS6PC Poly – For Inlets/Plugs Only.
	DS6MC Aluminum – For Inlets/Plugs Only. -A155 suffix required to maintain water ingress protection.

SPRING-LOADED PADLOCKABLE INLET/PLUG CAP	
	31-6A226 For Poly Inlets/Plugs Only.
	39-6A226 For Metal Inlets/Plugs Only.

-A155 suffix required to maintain water ingress protection.

RECEPTACLE LOCKING PIN	
	LP-843 Requires Padlockable Pawl option (-843) on receptacle.

DS100 Switch-Rated Plugs & Receptacles – 100 A

UL/CSA Ratings

- Max Amperage & Voltage**
100 A, 600 VAC
- Switch-Rating (AC Only)**
Branch Circuit & Motor Circuit Disconnect Switching
- Horsepower Ratings**

120V	1Ø	3 hp
240V	1Ø	7.5 hp
208V	3Ø	10 hp
240V	3Ø	10 hp
480V	3Ø	30 hp
- Short Circuit Rating**
65kA Close & Withstand
Testing was performed with RK5 time delay fuses sized at 100% of the devices rated ampacity. Alternate testing was performed with 175 A RK1 non-time delay Mersen fuses.
- Environmental Ratings**
Type 4X (Poly Standard)
Type 3R (Metal Standard)
Type 4X (Metal Optional)
- Temperature Range**
Min -40°F/Max 140°F
See pg 258 for temps below -15°F.
- Wiring Capacity**
Min 4 AWG Max 2/0 AWG
Aux Contacts - Max 14 AWG
Based on THHN wire sizes
- Certifications**
UL 2682, UL 1682, CSA 182.1

Receptacle (female)

Inlet (male)



North American UL/CSA Configuration

Voltage	Polarity	Part #		Part #	
		Poly	Metal	Poly	Metal
120V	1P+N+G	33-94165	37-94165	33-98165	37-98165
120 208V	3P+N+G	33-94167	37-94167	33-98167	37-98167
125V	1P+N+G	33-94075	37-94075	33-98075	37-98075
125 250V	2P+N+G	33-94076	37-94076	33-98076	37-98076
208V	2P+G	33-94162	37-94162	33-98162	37-98162
208V	3P+G	33-94163	37-94163	33-98163	37-98163
250V	2P+G	33-94072	37-94072	33-98072	37-98072
250V	3P+G	33-94073	37-94073	33-98073	37-98073
277V	1P+N+G	33-94045	37-94045	33-98045	37-98045
277 480V	3P+N+G	33-94047	37-94047	33-98047	37-98047
347 600V	3P+N+G	33-94147	37-94147	33-98147	37-98147
480V	2P+G	33-94042	37-94042	33-98042	37-98042
480V	3P+G	33-94043	37-94043	33-98043	37-98043
600V	2P+G	33-94142	37-94142	33-98142	37-98142
600V	3P+G	33-94143	37-94143	33-98143	37-98143

For international configurations and ratings (IEC/CE) visit meltric.com/international-catalog or contact customer service at 800-433-7642.

Main Options

- Auxiliary/Pilot Contacts
- Mushroom Pawl
- Padlock Pawl
- Closed Lid Configuration
Recommended for cord applications to keep lid tucked in to avoid damage

Receptacle Options

Suffix

Inlet Options

Suffix

With 2 Auxiliary/Pilot Contacts	Recept # - 262	With 2 Auxiliary/Pilot Contacts	Inlet # - 262
With 3 Auxiliary/Pilot Contacts	Recept # - 263	With 3 Auxiliary/Pilot Contacts	Inlet # - 263
With 4 Auxiliary/Pilot Contacts	Recept # - 264	With 4 Auxiliary/Pilot Contacts	Inlet # - 264
With 5 Auxiliary/Pilot Contacts	Recept # - 975	With 5 Auxiliary/Pilot Contacts	Inlet # - 975
With 6 Auxiliary/Pilot Contacts	Recept # - 976	With 6 Auxiliary/Pilot Contacts	Inlet # - 976
Type 4X & Closed Lid Configuration	Recept # - 4X ⁱ	Type 4X Watertightness	Inlet # - 4X ⁱ
Straight Insertion	Recept # - 352	Self-Ejecting Plug Release	Inlet # - 338
Self-Ejecting Connector Release	Recept # - 354	With No Lockout Hole	Inlet # - A155
Mushroom Pawl	Recept # - 375	For Auxiliary Switch	Inlet # - NNF*
Padlock Pawl	Recept # - 843		
Padlockable Mushroom Pawl	Recept # - 375-843		
Screw-Type Locking Pawl	Recept # - 845		
Metal Pawl (on Poly Receptacle)	Recept # - 824		
180° Opening Lid (metal only)	Recept # - 180++		
Closed Lid Configuration	Recept # - NC		
With Auxiliary Switch	Recept # - 270+		

Notes: * Order inlet with P+N+G configuration and receptacle with P+G configuration.
i Metal devices only.

Notes: + Not UL/CSA listed.
++ Required when mating to rigid mounted male inlet.
i Metal devices only.

Order Example: 480V DS100 + 2 auxiliary contacts
DS100 Poly inlet 3P+G = 33-98043-262

INSTALLATION ACCESSORIES – SIZE 5

Unless indicated otherwise, accessories can be used with either poly or metal plugs and receptacles.

HANDLES

HANDLE w/NPT		Part # Poly	Part # Metal
	3/4"	515P0N07	595P0N07
	1"	515P0N10	595P0N10
	1 1/4"	515P0N12	595P0N12
	1 1/2"	515P0N15	595P0N15
	2"	515P0N20	595P0N20
	For metal devices only		

For available cord grips, see page 167.

POLY HANDLE w/CORD GRIP	Cable Range	Part #
	.980 - 1.260"	715P0EP4
	1.260 - 1.560"	715P0FP1
	1.520 - 1.860"	715P0GP2

METAL HANDLE w/CORD GRIP	Cable Range	Part #
	1.250 - 1.375"	795P0FS1
	1.438 - 1.562"	795P0FS2*
	1.562 - 1.688"	795P0FS3*
	1.688 - 1.812"	795P0GS1
	*May require stripping of cable jacket.	

METAL OVERSIZED HANDLE w/NPT	Part #	
	3/4"	795P0N07
	1"	795P0N10
	1 1/4"	795P0N12
	1 1/2"	795P0N15
	2"	795P0N20
	2 1/2"	795P0N25





For available cord grips, see page 167.

SANTOPRENE HANDLE	Cable Range	Part #
	.70 - 1.000"	555P0D25
	.984 - 1.377"	555P0D35
	IP66/IP67 1.378 - 1.771"	555P0D45

POLY HANDLE w/CLAMP & BUSHING	Cable Range	Part #
	1.250 - 1.375"	715P0S22
	1.438 - 1.562"	715P0S25
	1.562 - 1.688"	715P0S27
	1.688 - 1.812"	715P0S29

ANGLES

POLY ANGLE	Angle	Part #
	30°	515M3

METAL ANGLE	Angle	Part #	Notes
	0°	595M0	
	30°	595M3	
	Oversized 30°	795M3	Mounts on oversize box only. Order with 7T6F0N25XL. See pg 52.
	70°	595M7	

BOXES

POLY ANGLE WITH METAL BOX w/NPT	Angle	Depth	Part #	Notes	
	30°	1 1/4"	715C3N12		
	30°	1 1/2"	715C3N15		
	30°	2"	715C3N20	* Interior volume with receptacle installed.	
	* 108.7 in ³	30°	2 1/2"	715C3N25	

METAL ANGLE WITH METAL BOX w/NPT	Angle	Depth	Part #	Notes
	30°	1 1/4"	795C3N12	
	30°	1 1/2"	795C3N15	
	30°	2"	795C3N20	* Interior volume with receptacle installed.
	* 111.8 in ³	30°	2 1/2"	795C3N25

METAL BOX w/NPT	Angle	Depth	Part #
	0°	1 1/4"	7T5F0N12
	0°	1 1/2"	7T5F0N15
	0°	2"	7T5F0N20
	0°	2 1/2"	7T5F0N25

NPT on top or bottom (if rotated). For other NPT configurations, contact customer service.

MISCELLANEOUS ACCESSORIES

PROTECTIVE INLET/PLUG CAP	Part #	Notes
	31-9A426	For Inlets/Plugs Only. Covers lockout hole for watertight seal on inlet. Consult Customer Service for availability.

PADLOCKABLE INLET/PLUG CAP	Part #	Notes
	DS9MC	Aluminum – For Inlets/Plugs Only. -A155 suffix required to maintain water ingress protection.

CORD GRIP with MESH	Part #
	see pg 167

EASY RETROFIT ADAPTER PLATES	Part #	Notes
	see pg 164	Mount to existing boxes.

RECEPTACLE LOCKING PIN	Part #	Notes
	LP-843	Requires Padlockable Pawl option (-843) on receptacle.

DS200 Switch-Rated Plugs & Receptacles – 200 A

UL/CSA Ratings

- **Max Amperage & Voltage**
200 A, 600 VAC
- **Switch-Rating (AC Only)**
Branch Circuit & Motor Circuit Disconnect Switching
- **Horsepower Ratings**

208V	3Ø	40 hp
240V	3Ø	40 hp
480V	3Ø	100 hp
600V	3Ø	100 hp
- **Short Circuit Rating**
65kA Close & Withstand
Testing was performed with RK5 time delay fuses sized at 100% of the devices rated ampacity.
10kA Close & Withstand
Testing was performed with RK1 current limiting fuses sized at 400% of the highest full load motor ampacity.
- **Environmental Ratings**
Type 3R (Standard)
Type 4X (Optional)
- **Temperature Range**
Min -40°F/Max 140°F
See pg 258 for temps below -15°F.
- **Wiring Capacity**
Min 4 AWG Max 4/0 AWG
Aux Contacts - Max 14 AWG
Based on THHN wire sizes
- **Certifications**
UL 2682, UL 1682, CSA 182.1

Receptacle (female)

Easy Closing Mechanism



If you have an existing removable and/or permanently attached drawbar, contact customer service.



Don't forget to add installation accessories to your order



Standard DS200 lid opens to 90°

Inlet (male)



Tabs for latching to closing mechanism

North American UL/CSA Configuration

Voltage	Polarity	Part # Metal	Part # Metal
120V	1P+N+G	37-24165	37-28165
120 208V	3P+N+G	37-24167	37-28167
125V	1P+N+G	37-24075	37-28075
125 250V	2P+N+G	37-24076	37-28076
208V	2P+G	37-24162	37-28162
208V	3P+G	37-24163	37-28163
250V	2P+G	37-24072	37-28072
250V	3P+G	37-24073	37-28073
277V	1P+N+G	37-24045	37-28045
277 480V	3P+N+G	37-24047	37-28047
347 600V	3P+N+G	37-24167	37-28167
480V	2P+G	37-24042	37-28042
480V	3P+G	37-24043	37-28043
600V	2P+G	37-24142	37-28142
600V	3P+G	37-24143	37-28143

For international configurations and ratings (IEC/CE) visit meltric.com/international-catalog or contact customer service at 800-433-7642.

Main Options



Auxiliary/Pilot Contacts



Mushroom Pawl



Padlock Pawl



Closed Lid Configuration
Recommended for cond applications to keep lid tucked in to avoid damage.

Receptacle Options

Suffix

Inlet Options

Suffix

- With 2 Auxiliary/Pilot Contacts
- With 4 Auxiliary/Pilot Contacts
- With 6 Auxiliary/Pilot Contacts
- Type 4X & Closed Lid Configuration
- Straight Insertion
- Mushroom Pawl
- Padlock Pawl
- Padlockable Mushroom Pawl
- Screw-Type Locking Pawl
- 180° Opening Lid
- Closed Lid Configuration
- With Auxiliary Switch

- Recept # - 972*
- Recept # - 174+
- Recept # - 976+
- Recept # - 4X
- Recept # - A188++
- Recept # - 375
- Recept # - 843
- Recept # - 375-843
- Recept # - 845
- Recept # - 180+++
- Recept # - NC
- Recept # - 270++

- With 2 Auxiliary/Pilot Contacts
- With 4 Auxiliary/Pilot Contacts
- With 6 Auxiliary/Pilot Contacts
- Type 4X Watertightness
- Self-Ejecting Plug Release
- For Auxiliary Switch
- With No Lockout Hole

Notes: * Customers needing to maintain compatibility with old style -172 auxiliary contacts should use a -172 suffix.
** Order inlet with P+N+G configuration and receptacle with P+G configuration.
* This option not available with N contact.
++ Not UL/CSA listed.

Notes: * Customers needing to maintain compatibility with old style -172 auxiliary contacts should use a -172 suffix.
+ This option not available with N contact.
++ Not UL/CSA listed.
+++ Required when mating to rigid mounted male inlet.

Order Example: 480V DS200 + 2 auxiliary contacts
DS200 Metal inlet 3P+G = 37-28043-972

See pages 235-244 for detailed information on these options

INSTALLATION ACCESSORIES – SIZE 6

Unless indicated otherwise, accessories can be used with either poly or metal plugs and receptacles.

HANDLES

HANDLE w/NPT	Part # Poly	Part # Metal
 1"	516PON10	596PON10
 1 1/4"	516PON12	596PON12
 1 1/2"	516PON15	596PON15
 2"	516PON20	596PON20
 2 1/2"	516PON25	596PON25
 3"	-	596PON30

For metal devices only

For available cord grips, see page 167.

POLY HANDLE w/CORD GRIP	Cable Range	Part #
	1.520 - 1.860"	716POGP2
	1.850 - 2.190"	716POGP3*

*May require stripping of cable jacket.

METAL HANDLE w/CORD GRIP	Part #
	796POGS1
	796POGS2*
	796POJS1
	796POJS2
	796POJS3
	796POJS4*
	796POKS1
	796POKS2

*May require stripping of cable jacket.

METAL OVERSIZED HANDLE w/NPT	Part #
	796PON12
	796PON15
	796PON20
	796PON25
	796PON30

For available cord grips, see page 167.

SANTOPRENE HANDLE	Part #
	556POD35
	556POD45
	556POD49

IP66/IP67

ANGLES

METAL ANGLE	Part #	Notes
 0°	596M0	
 Oversized 45°	796M4	Mounts on oversized metal box only. Order with 7T6F0N25XL.
 60°	596M6	
 Extended 60°	597M6	

BOXES

METAL ANGLE WITH METAL BOX w/NPT	Part #	Notes
 60° 1 1/2"	796C6N15	* Interior volume with receptacle installed.
60° 2"	796C6N20	
* 248.4 in ³ 60° 2 1/2"	796C6N25	

METAL BOX w/NPT	Part #	Notes
 0° 1 1/2"	7T6F0N15	* Interior volume with receptacle installed.
0° 2"	7T6F0N20	
0° 2 1/2"	7T6F0N25	

METAL OVERSIZED BOX w/NPT	Part #
 0° 2"	7T6F0N20XL
0° 2 1/2"	7T6F0N25XL
0° 3"	7T6F0N30XL

NPT on top or bottom (if rotated). For other NPT configurations, contact customer service.

MISCELLANEOUS ACCESSORIES

PROTECTIVE INLET/PLUG CAP	Part #	Notes
	39-2A426	Covers lockout hole for watertight seal on inlet. Consult Customer Service for availability. For Inlets/Plugs Only.

PADLOCKABLE INLET/PLUG CAP	Part #	Notes
	DS2MC	Aluminum – For Inlets/Plugs Only. -A155 suffix required to maintain water ingress protection.

CORD GRIP WITH MESH	Part #
	see pg 167

EASY RETROFIT ADAPTER PLATES	Part #	Notes
	see pg 164	Mount to existing boxes.

RECEPTACLE LOCKING PIN	Part #	Notes
	LP-843	Requires Padlockable Pawl option (-843) on receptacle.

DS SPARE PARTS Male Configuratio



		DS20 POLY	DS30 POLY	DS60 POLY	DS60 METAL	DS100C POLY	DS100C METAL	DS100 POLY	DS100 METAL	DS200 METAL
1 Plug Interior***		31-1A010*	31-3A010*	31-6A010*	31-6A010*	31-6A010-C*	31-6A010-C*	61-9A010*	69-9A010*	39-2A010*
1 Plug Interior w/Ground Contacts***		-	-	-	39-6A110*	-	39-6A110-C*	-	69-9A110*	39-2A110*
1 Plug Interior with 2 Pilots+		31-1A310-972*	31-3A310-972*	31-6A310-972*	31-6A310-972*	31-6A310-C-972*	31-6A310-C-972*	61-9A310-262*	69-9A310-262*	39-2A310-972*
2 Interior Bottom***		31-1A010-B	31-3A010-B	31-6A010-B	31-6A010-B	31-6A010-C-B	31-6A010-C-B	61-9A551	69-9A551	39-2A010-B
3 Interior Top***		31-1A010-T*	31-3A010-T*	31-6A010-T*	31-6A010-T*	31-6A010-C-T*	31-6A010-C-T*	61-9A010-T*	69-9A010-T*	39-2A010-T*
4 Polyester Locking Ring		31-1A583	31-3A583	31-6A583	-	31-6A583	-	31-9A583	-	-
4 Metal Locking Ring		-	-	-	39-6A583	-	39-6A583	-	39-9A583	39-2A583
5 Plug Phase Contact (if no aux. contacts)		31-1A011-380	31-3A011-380	31-6A011	31-6A011	31-6A011-C	31-6A011-C	61-9A011	61-9A011	39-2A011
5 Plug Phase Contact (if plug has aux. contacts)		31-1A011	31-3A011-380	31-6A011	31-6A011	31-6A011-C	31-6A011-C	61-9A011	61-9A011	39-2A011
5 Plug Ground Contact		31-1A019	31-3A019	31-6A019	31-6A019	31-6A019-C	39-6A019-C	61-9A019	69-9A019	39-2A019
6 Color-Coded Voltage Gasket	125V	31-1AC26	31-3AC26	31-6AC26	31-6AC26	31-6AC26	31-6AC26	31-9AC26	31-9AC26	39-2AC26
	208V	31-1AB26	31-3AB26	31-6AB26	31-6AB26	31-6AB26	31-6AB26	31-9AB26	31-9AB26	39-2AB26
	250V	31-1AC26	31-3AC26	31-6AC26	31-6AC26	31-6AC26	31-6AC26	31-9AC26	31-9AC26	39-2AC26
	480V	31-1AR26	31-3AR26	31-6AR26	31-6AR26	31-6AR26	31-6AR26	31-9AR26	31-9AR26	39-2AR26
	600V	31-1AN26	31-3AN26	31-6AN26	31-6AN26	31-6AN26	31-6AN26	31-9AN26	31-9AN26	39-2AN26
7 Plug Polyester Casing		31-1A014**	31-3A014**	31-6A014**	-	31-6A014-C**	-	61-9A014**	-	-
7 Plug Metal Casing		-	-	-	39-6A014**	-	39-6A014-C**	-	39-9A014**	39-2A014**
8 Type 4X Gasket		31-1A056	31-3A056	31-6A066	39-6A066	31-6A066	39-6A066	-	31-9A066	39-2A056

* Voltage and phasing positions must be specified (5th, 6th & 7th digit of Part #) to duplicate your shutter and alignment notches.

** For appropriate labeling on a device, please specify voltage, phasing, and product type.

*** For interiors with pilot contacts, contact Customer Service for part numbers.

+ For interiors with more than 2 pilot contacts, contact Customer Service for part numbers.

DS SPARE PARTS Female Configuratio



	DS20 POLY	DS30 POLY	DS60 POLY	DS60 METAL	DS100C POLY	DS100C METAL	DS100 POLY	DS100 METAL	DS200 METAL
1 Receptacle Interior***	31-1A020*	31-3A020*	31-6A020*	31-6A020*	31-6A020-C*	31-6A020-C*	61-9A020*	69-9A020*	39-2A020*
1 Recept Interior w/Ground Contacts***	-	-	-	39-6A220*	-	39-6A220-C*	-	69-9A220*	39-2A220*
1 Receptacle Interior with 2 Pilots+	31-1A320-972*	31-3A320-972*	31-6A320-972*	31-6A320-972*	31-6A320-C-972*	31-1A320-C-972*	61-9A320-262*	61-9A320-262*	39-2A320-972*
2 Interior Bottom***	31-1A020-B	31-3A020-B	31-6A020-B	31-6A020-B	31-6A020-C-B	31-6A020-C-B	61-9A552	69-9A552	39-2A020-B
3 Interior Top***	31-1A020-T*	31-3A020-T*	31-6A020-T*	31-6A020-T*	31-6A020-C-T*	31-6A020-C-T*	61-9A020-T*	69-9A020-T*	39-2A020-T*
4 Polyester Locking Ring	31-1A583	31-3A583	31-6A583	-	31-6A583	-	31-9A583	-	-
4 Metal Locking Ring	-	-	-	39-6A583	-	39-6A583	-	39-9A583	39-2A583
5 Recept Phase Contact [if no aux. contacts]	31-1A021-380	31-3A021-380	31-6A021	31-6A021	31-6A021-C	31-6A021-C	61-9A021	61-9A021	39-2A021
5 Recept Phase Contact [if plug has aux. contacts]	31-1A021	31-3A021-380	31-6A021	31-6A021	31-6A021-C	31-6A021-C	61-9A021	61-9A021	39-2A021
5 Recept Ground Contact	31-1A029	31-3A029	31-6A029	39-6A029	31-6A029-C	39-6A029-C	61-9A029	69-9A029	39-2A029
6 Color-Coded Voltage Gasket	125V	31-1AC26	31-3AC26	31-6AC26	31-6AC26	31-6AC26	31-9AC26	31-9AC26	39-2AC26
	208V	31-1AB26	31-3AB26	31-6AB26	31-6AB26	31-6AB26	31-9AB26	31-9AB26	39-2AB26
	250V	31-1AC26	31-3AC26	31-6AC26	31-6AC26	31-6AC26	31-9AC26	31-9AC26	39-2AC26
	480V	31-1AR26	31-3AR26	31-6AR26	31-6AR26	31-6AR26	31-9AR26	31-9AR26	39-2AR26
	600V	31-1AN26	31-3AN26	31-6AN26	31-6AN26	31-6AN26	31-9AN26	31-9AN26	39-2AN26
7 Receptacle Polyester Casing w/Lid	31-1A024**	31-3A024**	31-6A024**	-	31-6A024-C**	-	61-9A024**	-	-
7 Receptacle Metal Casing w/Lid	-	-	-	39-6A024**	-	39-6A024-C**	-	39-9A024**	39-2A024**
8 Lid Replacement Kit Polyester	31-1A125	31-3A125	31-6A425	-	31-6A425	-	61-9A125	-	-
8 Lid Replacement Kit Metal	-	-	-	39-6A925	-	39-6A925	-	39-9A925	39-2A925
9 Pawl Replacement Kit Polyester	31-1A824	31-3A824	31-6A824	-	31-6A824	-	61-9A824	-	-
9 Pawl Replacement Kit Metal	39-1A824	39-3A824	39-6A824	39-6A824	39-6A824	39-6A824	69-9A924	39-9A824	39-2A824

* Voltage and phasing positions must be specified (5th, 6th & 7th digit of Part #) to duplicate your shutter and alignment notches.

** For appropriate labeling on a device, please specify voltage, phasing, and product type.

*** For interiors with more than 2 pilot contacts, contact Customer Service for part numbers.

+ For interiors with more than 2 pilot contacts, contact Customer Service for part numbers.

For replacement parts contact customer service at 800-433-7642

DS DIMENSIONS – Provided in inches

Dimensions are for reference only and may change depending on accessories used. For precise dimensions contact MELTRIC Engineering.

Plug

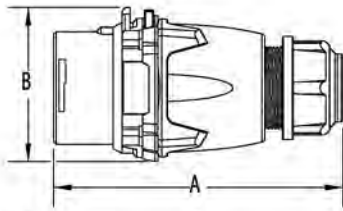

Inlet

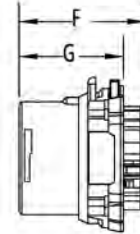
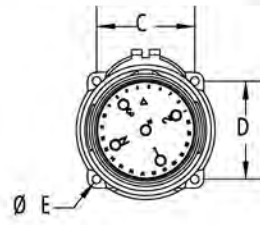

PRODUCT	A	B	C	D	ØE	F	G
DS20	5.72	2.79	1.89	1.89	0.2	2.28	1.86
DS30	6.15	3.23	2.17	2.17	0.2	2.93	2.07
DS60/DS100c/DS7c	6.70	3.77	2.59	2.59	0.24	3.42	2.38
DS100	8.33	4.59	3.20	3.2	0.24	4.14	3.04
DS200	10.30	5.67	3.86	3.86	0.26	4.66	3.20

Connector

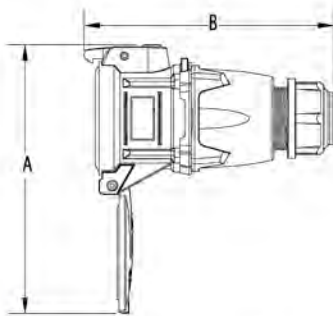

Receptacle

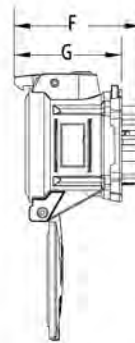
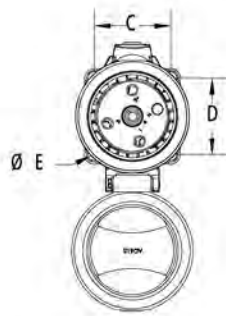

Extended Draw bars

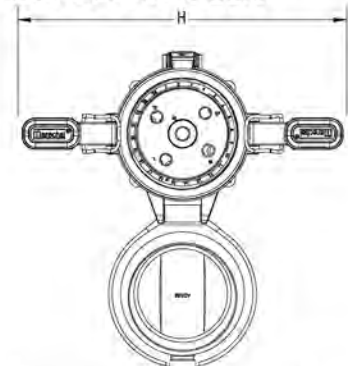

PRODUCT	A	B	C	D	ØE	F	G	H
DS20	6.32	6.38	1.89	1.89	0.2	3.3	2.60	N/A
DS30	7.16	6.93	2.17	2.17	0.2	3.73	2.87	N/A
DS60/DS100c/DS7c	8.46	7.75	2.59	2.59	0.22	4.53	3.37	N/A
DS100	11.04	10.02	3.20	3.2	0.23	5.71	4.74	11.25
DS200	11.54	10.87	3.86	3.86	0.26	6.21	4.75	12.07

Box/30° Angle/ Receptacle/Plug

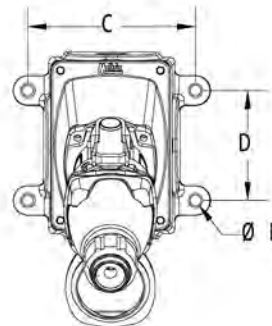
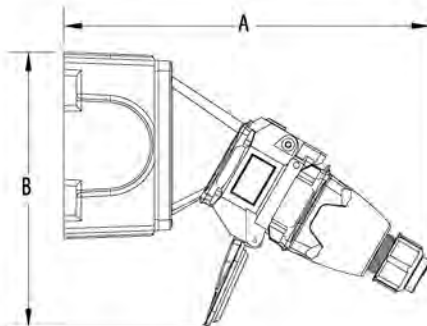

PRODUCT	A	B	C	D	ØE
DS20	9.84	7.29	4.19	2.75	0.27
DS30	10.30	8.39	4.19	2.75	0.27
DS60/DS100c/DS7c	11.87	10.45	5.00	3.81	0.33
DS100	16.06	11.77	6.75	4.25	0.31
DS200	15.76	11.54	8.13	6.38	0.31



30° Angle/Receptacle/Plug

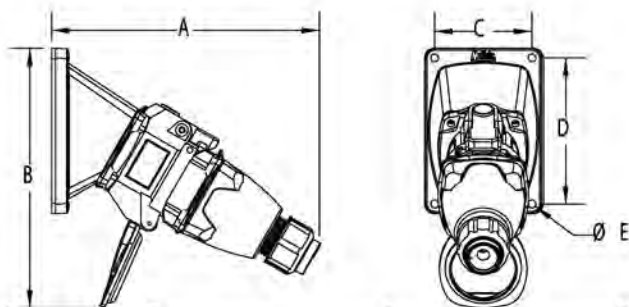

PRODUCT	A	B	C	D	∅E
DS20	7.60	7.87	2.50	3.75	0.22
DS30	8.19	8.44	2.50	3.75	0.22
DS60/DS100c/DS7c	9.17	10.16	3.43	4.83	0.26
DS100	14.09	12.05	4.83	4.83	0.28
DS200	11.61	15.03	6.50	6.50	0.25

70° Wall Box/Receptacle

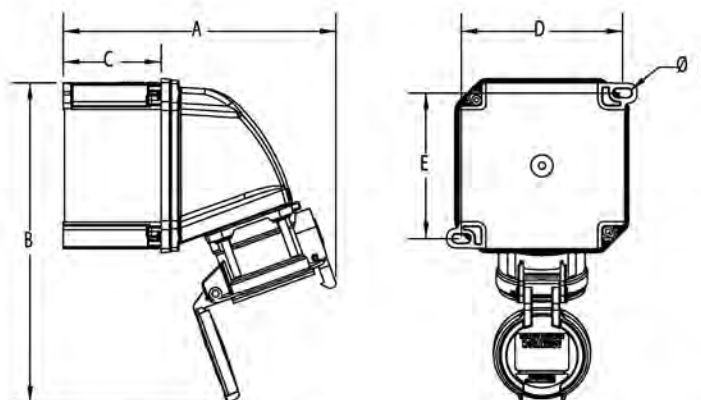

PRODUCT	A	B	C	D	E	∅F
DS20	7.78	9.11	2.80	4.60	4.15	0.26
DS30*	8.91	11.55	2.80	6.17	5.73	0.26
DS60/DS100c/DS7c*	9.07	12.24	2.80	6.17	5.73	0.26

* Box has 4 mounting feet

Plug/Connector

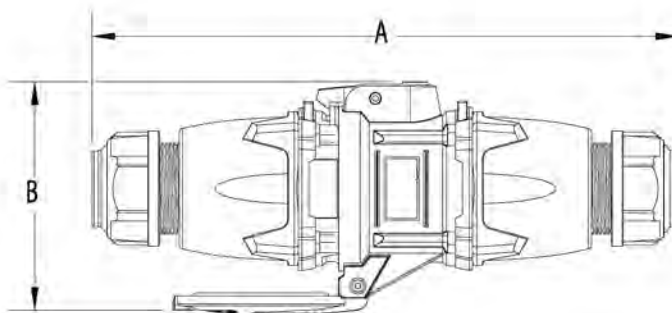

PRODUCT	A	B
DS20	10.20	4.61
DS30	10.91	5.71
DS60/DS100c/DS7c	12.17	6.57
DS100	19.53	8.03
DS200	23.15	8.00

